

# edilportale<sup>®</sup>

## TOUR 2017

Ristrutturazione, riqualificazione energetica, comfort abitativo, adeguamento antisismico, BIM



Roofingreen



Brescia, 17 maggio 2017

**LANE MINERALI  
CON ECOSE<sup>®</sup> TECHNOLOGY PER PROGETTAZIONI  
ALTAMENTE SOSTENIBILI E PRESTAZIONALI**

**Dott.ssa Marta Banfi**



**Progetto F.I.CO. (Fabbrica Italiana Contadina)  
Eataly World – area ex C.A.A.B. BOLOGNA**

**Committenza: Prelios SGR - Eataly**

**Impresa esecutrice: Consorzio Cooperative  
Costruzioni (CMB Carpi)**

**Prog. Architettonico: Tecnopolis - BO**

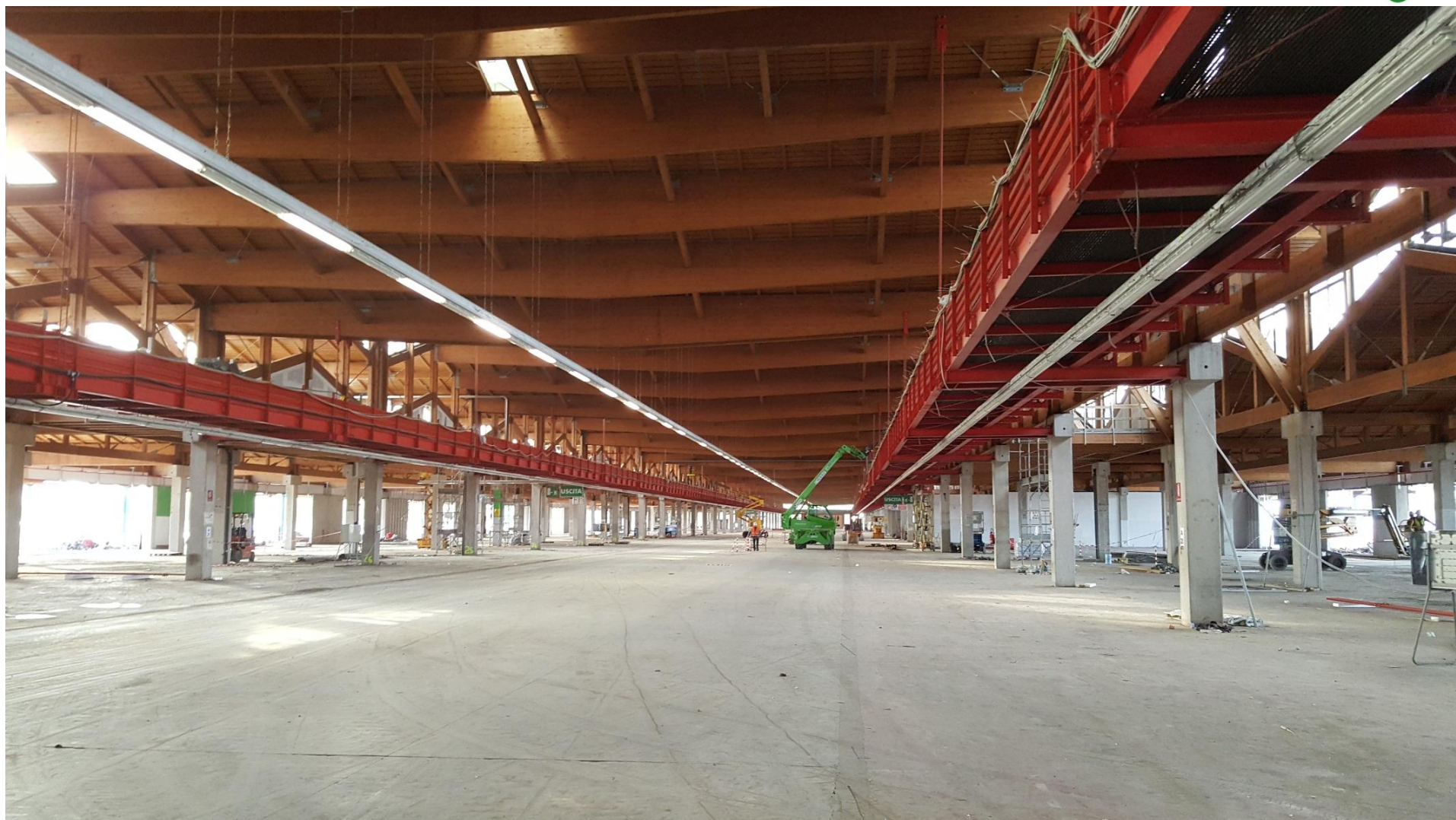

**Spazi interni area C.A.A.B. da riqualificare.**



- **F.I.CO. (Fabbrica Italiana Contadina)**: area ex CAAB, si compone di 2 lotti >> mercato ortofrutticolo (NAM) e lotto A (Eataly).
- Impresa esecutrice: *CMB Carpi*
- Progetto definitivo e DL: *Tecnopolis\_Bologna*
- Progettisti impresa exec.: *Politecnica\_Modena*

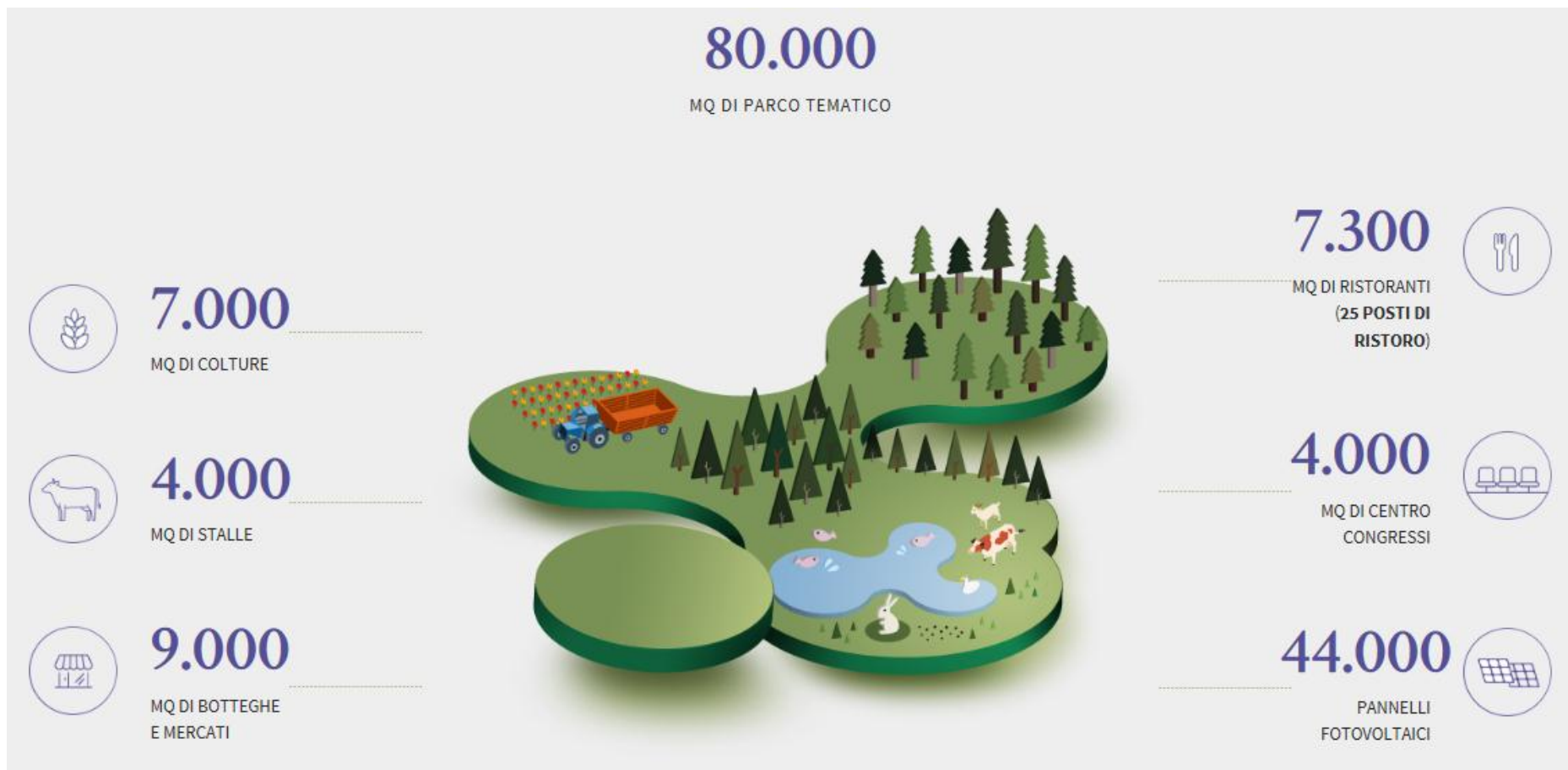









**Target progetto:**

- **Riqualificare spazi, creando nuove partizioni da installare in tempi rapidi, con il minimo ingombro e le massime prestazioni di isolamento termico (contropareti su pannelli pref. Perimetrali), acustico e di sicurezza al fuoco.**



**Pareti/contropareti a secco**



**Materiali isolanti:**

- **Prestazioni acustiche**
- **Sicurezza al fuoco**
- **Praticità e velocità di posa**
- **Sostenibilità ambientale**
- **Economicità**



**Lane minerali Knauf Insulation  
con Ecosse<sup>®</sup> Technology**

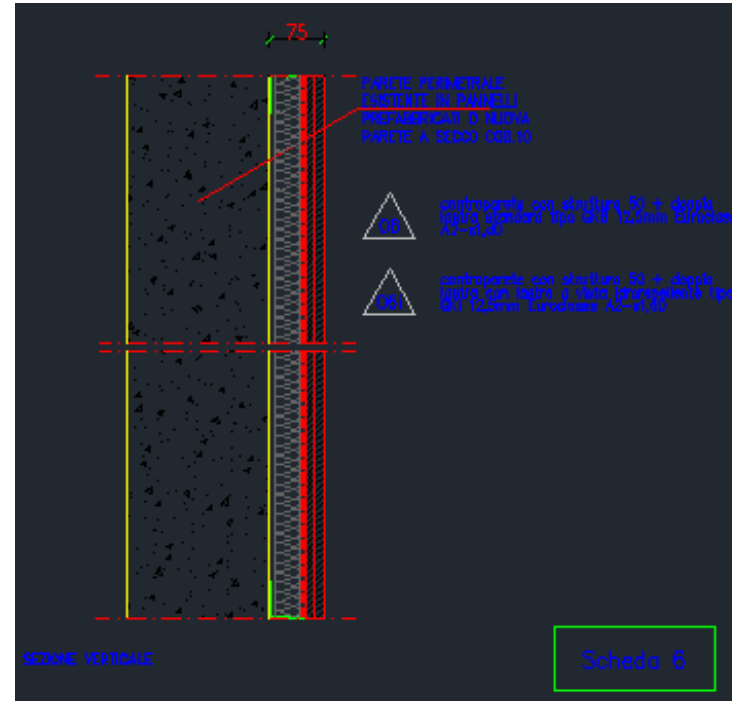
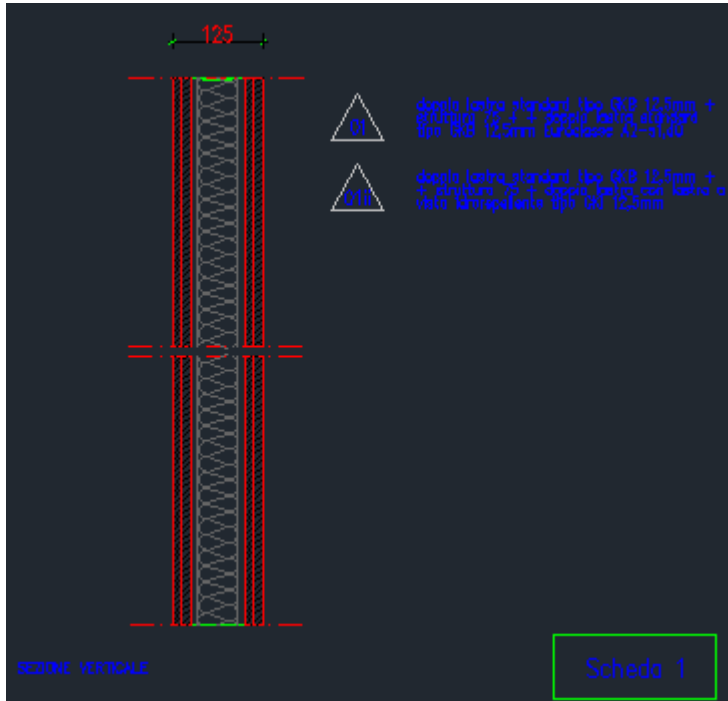



with **ECOSE**<sup>™</sup>  
TECHNOLOGY



## #EceseNothingBeatsTheOriginal





***Ecosse**<sup>®</sup> Technology: una nuova  
generazione di isolanti,  
che compie già 8 anni....*

with **ECOSE**<sup>™</sup>  
TECHNOLOGY

**LANA MINERALE**  
**SENZA FORMALDEIDE AGGIUNTA**  
#EcosseNothingBeatsTheOriginal



# Che cos'è **ECOSE**<sup>®</sup> Technology?

... una tecnologia rivoluzionaria,  
che prevede l'utilizzo di una resina  
di origine vegetale priva di  
formaldeide, che non contiene  
fenoli e composti acrilici, prodotta  
con materiali facilmente rinnovabili  
e senza additivi coloranti



**ECOSE**<sup>®</sup> Technology è una tecnologia brevettata rivoluzionaria, applicabile ai processi industriali



## Benefici di **ECOSE**<sup>®</sup> Technology

**Naturale – resina di origine vegetale senza formaldeide, che non contiene fenoli e composti acrilici**

- Migliorata qualità dell'aria interna (minori emissioni di VOC)
- Certificato **INDOOR AIR COMFORT GOLD – EUROFINS**
- Contiene fino a un **80% di vetro riciclato**
- Ridotto impatto ambientale, grazie alla minore richiesta di energia durante la fase di produzione (-70%)
- Minori investimenti per il trattamento dei fumi



## I vantaggi di Ecose<sup>®</sup> Technology:

- ✓ Materiale sostenibile
- ✓ Elevate performance di isolamento termico e acustico
- ✓ Incombustibile (A1)
- ✓ Qualità dell'aria indoor
- ✓ Facilità di posa
- ✓ Non spolvera
- ✓ Non pizzica
- ✓ E' inodore





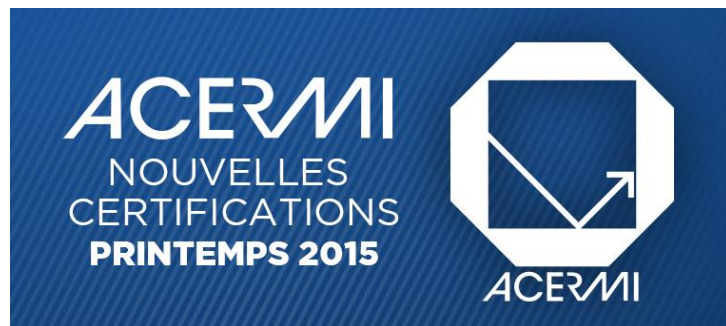
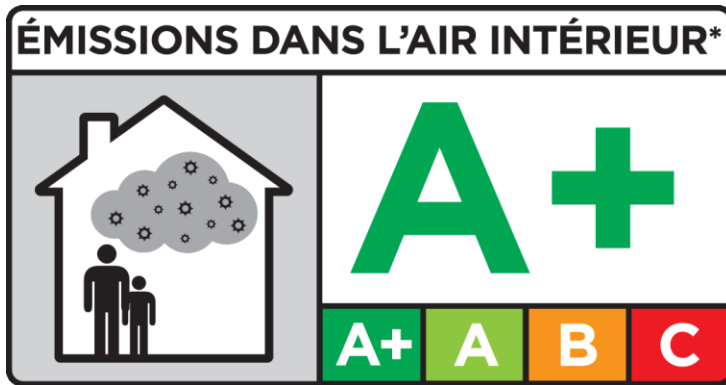

**ENVIRONMENTAL PRODUCT DECLARATION**

as per ISO 14025 and EN 15804

Owner of the Declaration	<b>Knauf Insulation</b>
Programme holder	Institut Bauen und Umwelt e.V. (IBU)
Publisher	Institut Bauen und Umwelt e.V. (IBU)
Declaration number	EPD-KNI-20160050-CBB1-EN
Issue date	4/12/2018
Valid to	4/11/2021

**Mineral Wool 034-035 Slabs**

MW 35, Mineral Wool 35, Mineral Wool KP 035, Mineral Wool KP 034

with **ECOSE<sup>®</sup> Technology**

**Knauf Insulation**

[www.bau-umwelt.com](http://www.bau-umwelt.com) / <https://epd-online.com>





# CONTRIBUTING TO GREEN BUILDING RATINGS SYSTEMS

*Our contribution to Green Building Rating Systems such as BREEAM and LEED were deciding factors in the choice of our products. Here are two examples of how Knauf Insulation products contribute to greener, more sustainable buildings.*

*"Blowing wool in building projects had good experience. It was the obvious choice."*

## OFFICE BUILDING, NORWAY

**Certification achieved**  
BREEAM - Very Good with energy class B in line with the BREEAM NOR (Norway) environmental standard.

**Product used**  
SUPAFIL Primo into 2,200m<sup>2</sup> of wall space.

**Project**  
25,000m<sup>2</sup> Norwegian office development by construction giant Skanska. The new four-story building for oil company Aibel in the city of Bergen features 900 office spaces, a gym, cycle parking and a naturally illuminated atrium at the heart of the building.

**Challenge**  
To fill a dry "hook and cranny" in the wall.

**Solution**  
Isomax Energi AS installed SUPAFIL ensuring a smooth and efficient installation process in timber frame construction to fill the voids.

**Benefits**  
SUPAFIL reduces the environmental impact of the building and is manufactured with up to 60% recycled glass.

*"Isomax Energi AS in Norway is a nationwide blowing wool insulation contractor that only uses SUPAFIL. As a result of the high quality of the solutions we provide, we have enjoyed a strong working relationship with the international construction company Skanska since 2011. This continuing collaboration between our companies has led to many prestigious projects in Norway, including the Aibel building in Bergen." **Tore J. Barstad, CEO, Isomax Energi AS.***





- **F.I.CO. (Fabbrica Italiana Contadina)**: mercato ortofrutticolo già ultimato, lavori a secco realizzati con isolanti Knauf Insulation.



- **F.I.CO. (Fabbrica Italiana Contadina)**: Lotto A (Eataly), in corso i i lavori. Le lavorazioni a secco sono realizzate anche per questo lotto con lane minerali Knauf Insulation.

**Materiali previsti:**

- **Divisori a secco: Ultracoustic R sp. 70 mm, circa **16000 mq****
- **Divisori a secco: Ultracoustic R sp. 60 mm, circa **1600 mq****
- **Divisori a secco: Ultracoustic R sp. 45 mm, circa **6000 mq****
- **Divisori a secco: DP7 sp. 80 mm, circa **1600 mq****
- **Divisori a secco: TP 138 sp. 40 mm, circa **1600 mq****
- **Da definire quantità isolanti per controsoffitti a secco**

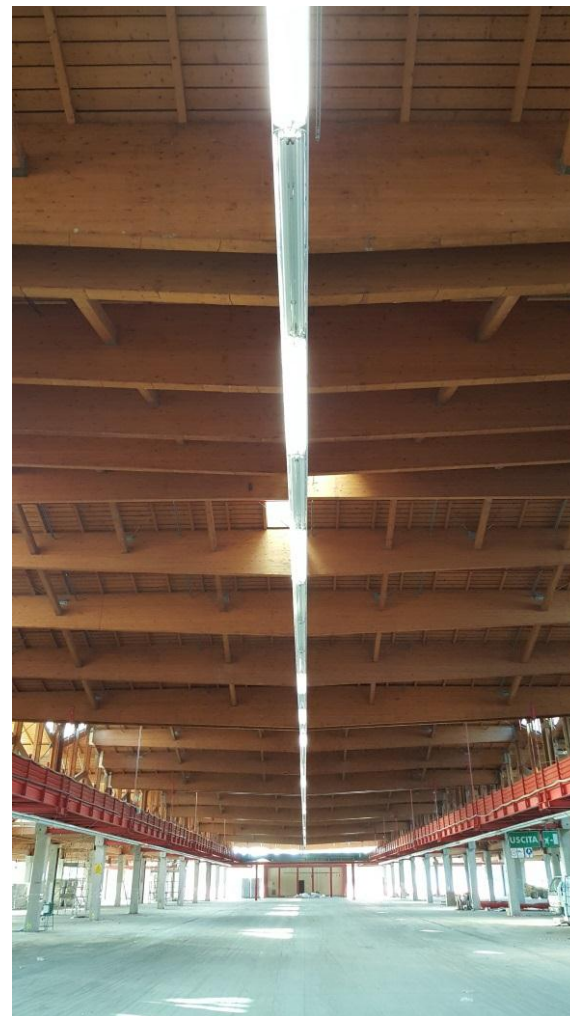



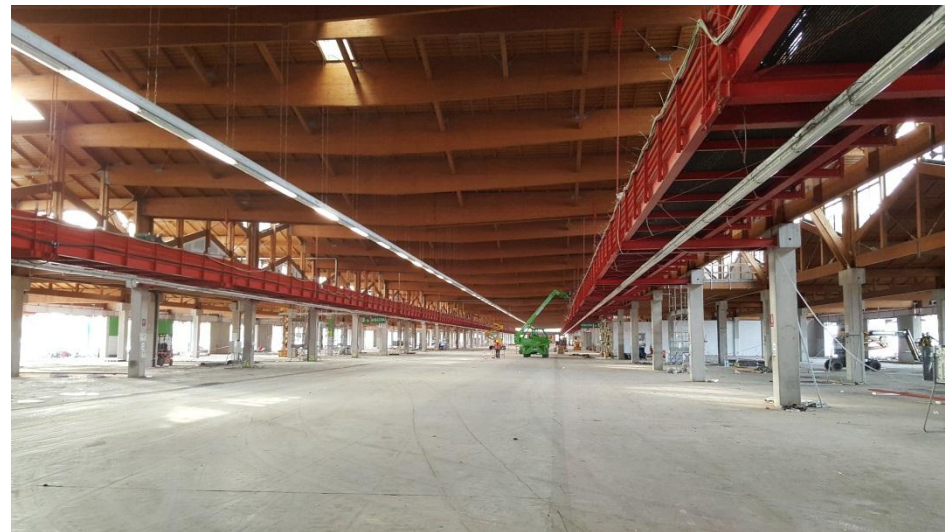



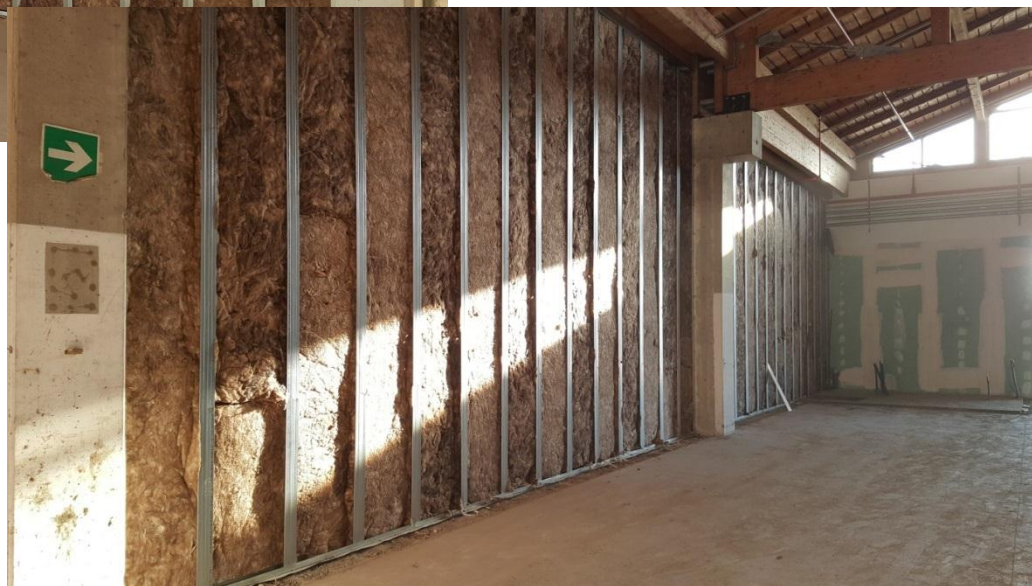











## **LANE MINERALI PER SISTEMI A SECCO INDOOR**



## New REVOLUTIONARY Product

- Lana minerale per divisori interni
- Elevate performance
- Facilità di utilizzo
- Facile da maneggiare
- Flessibile e robusta
- Piacevole al tatto



MINERAL WOOL 35		
Caratteristiche	Valore	Unità di misura
Dimensioni dei pannelli	600 x 1200	mm
Spessori disponibili	40, 50, 60, 70, 80, 100, 120	mm
<b>Conducibilità termica dichiarata <math>\lambda_D</math></b>	<b>0,035</b>	<b>W/mK</b>
Reazione al fuoco	A1	Euroclasse
Calore specifico (Cp)	1.030	J/kgK
Resistenza al passaggio del vapore acqueo	1	$\mu$

## Imballo compatto

- Ampia copertura della superficie per confezione
- Meno spazio per lo stoccaggio
- Meno problemi in cantiere



### Mineral Wool 35

1 pacco = **12,96 m<sup>2</sup>**

1 bancale = 24 pacchi = **311,04 m<sup>2</sup>**

### DP4

1 pacco = **7,2 m<sup>2</sup>**

1 bancale = 10 pacchi = **72 m<sup>2</sup>**





**CARATTERISTICHE  
TECNICHE**

## PERFORMANCE ACUSTICHE

---

Le soluzioni di parete a secco illustrate sono state testate presso l'Istituto Giordano, i certificati sono disponibili al sito [www.knaufinsulation.it](http://www.knaufinsulation.it)

✓ **Isolamento acustico**  
**R<sub>w</sub> 54 dB**

(Certificato Ist. Giordano N° 329508)

- n. 2 lastre cartongesso GKB Knauf per lato
- n. 1 pannello Mineral Wool 35 sp.40 mm



✓ **Isolamento acustico**  
**R<sub>w</sub> 56 dB**

(Certificato Ist. Giordano N° 329509)

- n. 2 lastre cartongesso Diamant Knauf per lato
- n. 1 pannello Mineral Wool 35 sp.60 mm  
(Con 2 lastre cartongesso GKB Knauf R<sub>w</sub> 55 dB  
Certificato Ist. Giordano N° 330226)



## PERFORMANCE ACUSTICHE

Le soluzioni di parete a secco illustrate sono state testate presso l'Istituto Giordano, i certificati sono disponibili al sito [www.knaufinsulation.it](http://www.knaufinsulation.it)



✓ **Isolamento acustico**  
**R<sub>w</sub> 62 dB**

(Certificato Ist. Giordano N° 329510)

- n. 2 lastre cartongesso GKB Knauf per lato
- n. 2 pannelli Mineral Wool 35 sp.40 mm



✓ **Isolamento acustico**  
**R<sub>w</sub> 63 dB**

(Certificato Ist. Giordano N° 329511)

- n. 2 lastre cartongesso GKB Knauf per lato
- n. 1 lastra GKB Knauf interna
- n. 2 pannelli Mineral Wool 35 sp.60 mm





# Mineral Wool 35

Mineral Wool 35



Lana tradizionale





# Mineral Wool 35

Mineral Wool 35



Lana tradizionale







**Seguici su**

-  **KnaufInsulationItalia**
-  **Knaufinsulationitalia**
-  **knaufinsulationitalia**

**[www.knaufinsulation.it](http://www.knaufinsulation.it)**

**[marta.banfi@knaufinsulation.com](mailto:marta.banfi@knaufinsulation.com)**

**342\_5653193**